



METEOROLOGICAL INSTRUMENTS

INSTRUCTIONS

WIND TRACKER MODEL 06201



MODEL 06201 WIND TRACKER



FRONT PANEL

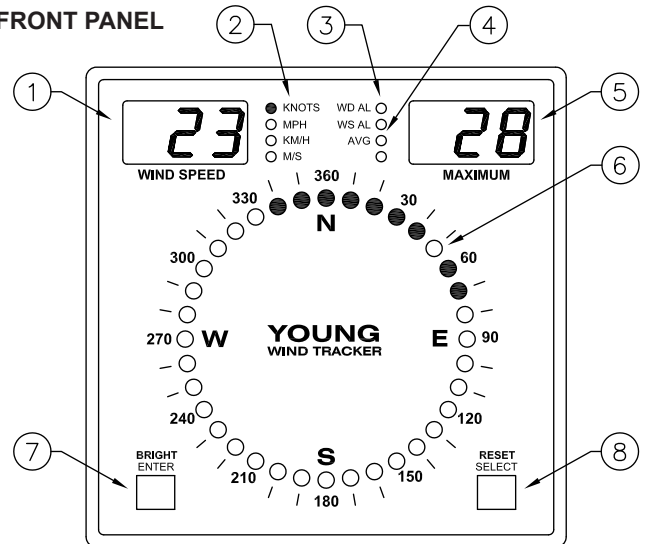

INTRODUCTION

The YOUNG Model 06201 Wind Tracker is a compact wind speed and direction display with advanced features for use in a wide range of applications.

FEATURES

- 3-digit wind speed display
- 3-digit maximum wind speed or wind direction display
- Multi-color wind direction display with variability
- Wind speed and direction alarms with delay
- RS-485 serial connections
- Calibrated 0-5 VDC outputs
- Display brightness control
- Compatible with YOUNG wind sensors & 4-20 mA inputs

PRECAUTIONS

- INDOOR USE ONLY unless placed in approved enclosure
- Operating temperature range 0-50°C (32-122°F), 0-95% RH
- Use only recommended power sources. 12-30 VDC, 3.5 W
- Disconnect power when connecting or servicing
- Alarm contact rating 24 VAC/30 VDC, 5 A resistive, 2 A inductive maximum

FACTORY DEFAULT SETTINGS

INPUT:

- Sensor Input Setting: "05" Wind Monitor
- Input selector switch position: "Down" (Sensor)

OPTIONS:

- Averaging: "No"
- Right hand display window: "Max Wind Speed"
- Alarms: "No"

OUTPUT:

- Voltage Outputs: 0-5Vdc=0-100m/s / 0-5Vdc = 0-360°
- Serial Output Type: "Binary"

IMPORTANT NOTE!:

Before connecting any external devices, verify the above settings are compatible with your application. If different, refer to the wiring diagrams for the correct settings.

1. Wind speed display
2. Wind speed units indicator
3. Alarm status indicators
4. Data averaging indicator
5. Maximum wind speed or direction display
6. Wind direction and variability display
7. Brightness control (operate) or Enter key (setup)
8. Maximum Reset (operate) or Select (setup)

BACK PANEL

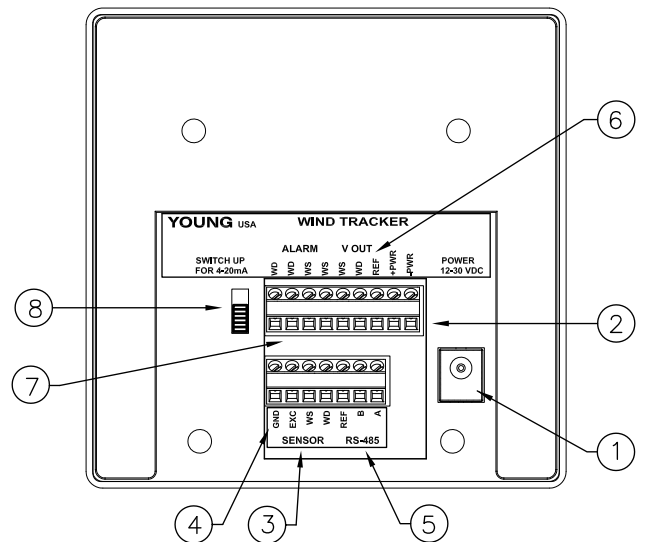

1. Power input coaxial jack (12-30 VDC)
2. Power input terminals (12-30 VDC)
3. Sensor or 4-20 mA inputs
4. Earth ground connection
5. RS-485 serial input/output
6. 0-5 VDC calibrated outputs
7. Alarm relay connections (Normally Open)
8. Input Selector Switch (Sensor or 4-20mA)

MOUNTING AND START-UP

- For best visibility, place the Wind Tracker in a location free of direct sunlight. Mount it using the attached bracket or remove bracket for flush mounting to a bulkhead or panel cutout. Panel cutout dimensions are given in the specifications. An optional rack mounting panel (Model 06280) and protective enclosure (Model 06260) are available from your YOUNG supplier.
- Connect cables to terminals according to wiring diagram.

IMPORTANT NOTE! Please observe correct position of back-panel Input Selector Switch according to wiring diagram.

- Connect GND terminal to suitable earth ground.
- Insert power supply plug into power jack, plug power supply into a suitable AC wall outlet or connect to suitable 12 to 30 VDC power source to terminals.

IMPORTANT NOTE! Do not connect more than one power source to the Wind Tracker at the same time.

- When power is applied, the Wind Tracker will display firmware version number then begin to display wind information as follows:
 - Wind speed
 - Wind speed units
 - Maximum wind speed or direction degrees
 - Wind direction (single orange indicator)
 - Direction variability (green indicators)
 - Alarm status indicators (if selected)
 - Wind speed & direction averaging indicator (if selected)
- Observe display to confirm proper operation.

CHANGING SETTINGS

Wind Tracker parameters may be inspected or changed in SETUP mode which is enabled by simultaneously pressing both **ENTER** and **SELECT** keys for about 4 seconds. When SETUP mode is active, abbreviations identify each function and available options as listed below. The **SELECT** key changes options or values. The **ENTER** key saves and moves to the next parameter.

Appearance of options depends on parameter settings. Some options may be hidden.

DISPLAY	SETUP FUNCTION
---------	----------------

Input/Sensor Type	
InP 03	Wind Sentry
04	Wind Monitor-Jr
05	Wind Monitor
05A	Wind Monitor-AQ
09	Wind Monitor-SE or YOUNG sonic anemometer
SEr	Serial input when used as remote display
Ld2	Line Driver 4-20mA input (0-100 m/s)
Hd	Wind Monitor HD
Ldi	Line Driver 4-20mA input (0-50 m/s)

Wind Speed Units (annunciator blinks)
SPd unt SELECT key changes units. ENTER to save

dSP	no	Display Averaging (annunciator blinks)
	YES	Instantaneous data displayed
		Average data displayed
PEr	030	Set averaging period in seconds (0-999). Display will update at this interval.
Right Display Window Selection		
dSP	SPd	Maximum wind speed
	dir	Wind Direction degrees
Wind Direction Alarm (annunciator blinks)		
ALr	no	Direction alarm not armed
	YES	Direction alarm armed
ALr	dir	SELECT key sets direction alarm sector start. ENTER key saves.
ALr	SPn	SELECT key sets direction alarm sector span. ENTER key saves.
Wind Speed Alarm (annunciator blinks)		
ALr	no	Speed alarm not armed
	YES	Speed alarm armed
ALr	000	Alarm set-point. SELECT key increments value. ENTER key saves.
Alarm Delay Time		
dLY	030	Alarm delay time in seconds (0-999). SELECT key increments value. ENTER key saves.
Sound		
Snd	no	No sound
	YES	Audible beep with alarm activations or average update.
Wind Direction Voltage Output Scale		
dir	360	0-360 degrees
	540	0-540 degrees
Serial Output Type		
Out	bin	Binary output for remote Wind Tracker displays
	ASC	ASCII text wind speed & direction
Test Functions		
tSt	no	No test
	YES	Test
tSt	ALr	SELECT key closes alarm relays.
CAL	0.00	SELECT key alternates between 0.00 and 5.00 VDC output to calibrate external devices.
tSt	dsP	SELECT key tests display sections.

OPERATION

ALARMS

Wind speed and direction alarms each have their own set-point, LED status indicator, and relay contacts. The Alarm Delay parameter establishes time duration in or out of the set-point range needed for the alarm to change state. Front panel LEDs indicate alarm status during operation.

LED Off = Alarm not armed and OFF. Relay open
 LED Steady = Alarm armed and OFF. Relay open
 LED Blinking = Alarm armed and ON. Relay closed.
 Audible beep if Sound parameter is enabled.

AVERAGING

When averaging is enabled, the front-panel AVG annunciator is illuminated, and average wind speed and direction values are displayed at intervals set by the Period (PEr) parameter. When averaging is disabled, instantaneous wind values are displayed.

BRIGHTNESS

Adjust display brightness by pressing and holding the left BRIGHT key for 1 second.

MAXIMUM or WIND DIRECTION DISPLAY

Either MAXIMUM WIND SPEED GUST or numerical WIND DIRECTION appears during operation depending on Right Display Window (dSP) parameter setting. Maximum gust may be reset during normal operation by pressing and holding the RESET key for 1 second.

REMOTE DISPLAYS

When set for any non-serial input, the Wind Tracker functions as a master display source for other Wind Trackers which have been configured for remote display with InP=SEr. The master Wind Tracker must also be set for binary serial output (Out=bin).

MASTER: Sensor InP = any non-serial device, Out=bin
REMOTE: Sensor InP = SEr

Connect one Wind Tracker master to up to 16 remote displays via the RS-485 terminals as shown in wiring diagrams. Remote Wind Trackers display exactly the same information as the master including alarm states. MAX RESET and all display features are controlled by the master unit only. Brightness can be adjusted independently at each Wind Tracker display.

VOLTAGE OUTPUTS

Calibrated voltage outputs for wind speed and direction are updated 16 times per second. Wind Speed 0-100 m/s = 0.00 to 5.00 VDC. Wind Direction may be scaled for either 0-360 or 0-540 degrees = 0.00 to 5.00 VDC by setting the Direction (dir) parameter.

4-20 mA INPUTS

The Wind Tracker accepts 4-20 mA Line Driver inputs with either 0-50 m/s or 0-100 m/s scaling (Ldi and Ld2 input settings). Connect as shown in wiring diagram. The back-panel switch labeled 4-20 mA must be in the UP position. 24VDC power is recommended for most 4-20 mA installations.

POWER CONNECTIONS

The Wind Tracker operates from a 12 to 30 VDC power source. Power may be connected via the coaxial jack or terminals. These are internally wired in together so DO NOT CONNECT MORE THAN ONE POWER SOURCE AT THE SAME TIME. See wiring diagrams for examples.

ERROR MESSAGES

Ldi	Err	4-20 mA (line driver) signal is missing or outside an acceptable range. Verify connections, signal, and 4-20 mA switch in UP position.
SEr	Err	Unit set to receive RS-485 serial signal (inP=SEr or 09), but no serial data detected. Verify serial source is working. Verify connections.

SPECIFICATIONS

Size:	144 mm (5.65 in) x 144 mm (5.65 in) x 36 mm (1.4 in)
Panel Cutout:	138 mm (5.43 in) x 138 mm (5.43 in)
Sensors:	Wind Monitor (05), Wind Monitor-AQ (05A), Wind Monitor-SE (09), Ultrasonic Anemometer (09), Wind Monitor-JR (04), Wind Sentry (03), Wind Monitor HD (Hd)
Accuracy:	±0.6% Full Scale
Serial I/O:	Proprietary binary I/O for master-remote display or simple ASCII text output for external device: ss.s ddd<cr><lf> ss.s windspeed (m/s) ddd wind direction in degrees RS-485 half-duplex, 9600 baud, 8-1-n, no handshaking
Other inputs:	4-20 mA (0-360 deg, Ldi 0-50 m/s, Ld2 0-100 m/s)
Other outputs:	0-5 VDC = 0-360° or 0-540° 0-5 VDC = 0-100 m/s
Alarm Relays:	Normally Open contacts for WS and WD Contact rating 24 VAC or 30 VDC maximum 5A resistive, 2A inductive maximum
Input Power:	12-30 VDC, 3.5 W
Weight:	1.0 lb (0.45 kg) without AC adapter

WARRANTY

The Wind Tracker is warranted to be free of defects in materials and construction for a period of 12 months from date of purchase. Coverage is limited to repair or replacement of defective unit.

WIRING DIAGRAMS

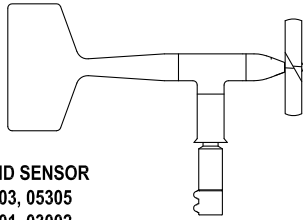

WIND SENSOR
05103, 05305
04101, 03002

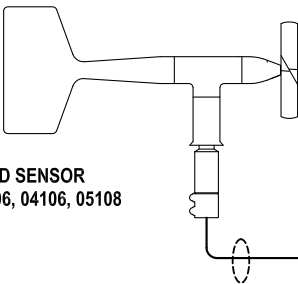
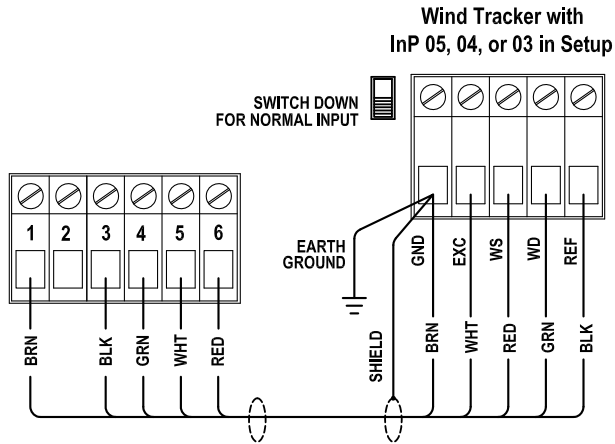

WIND SENSOR
05106, 04106, 05108

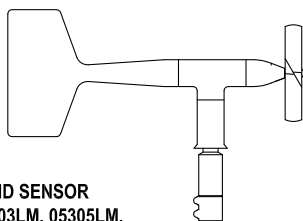
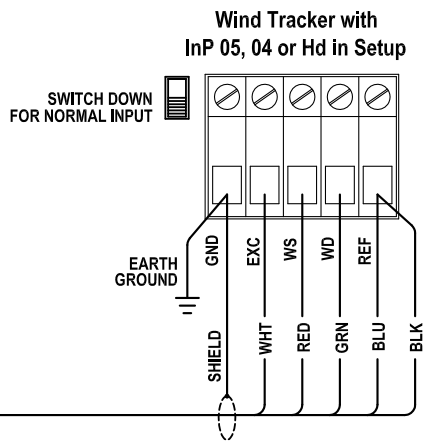

WIND SENSOR
05103LM, 05305LM,
04101LM, 03002LM
(0-50 m/s)

05103L, 05305L
(0-100 m/s)

4-20 mA OUTPUTS

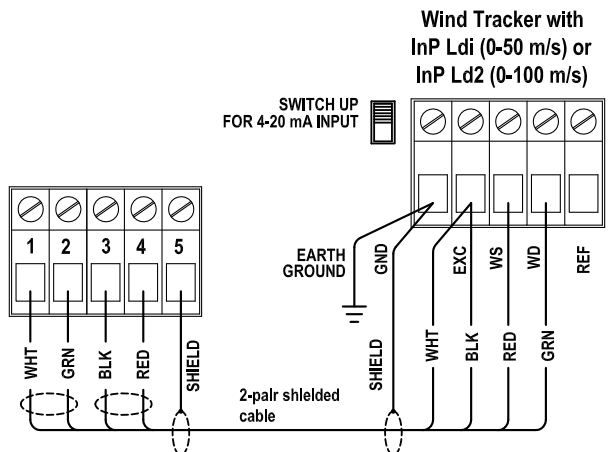

WIRING DIAGRAMS

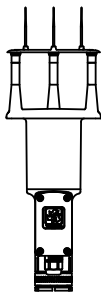
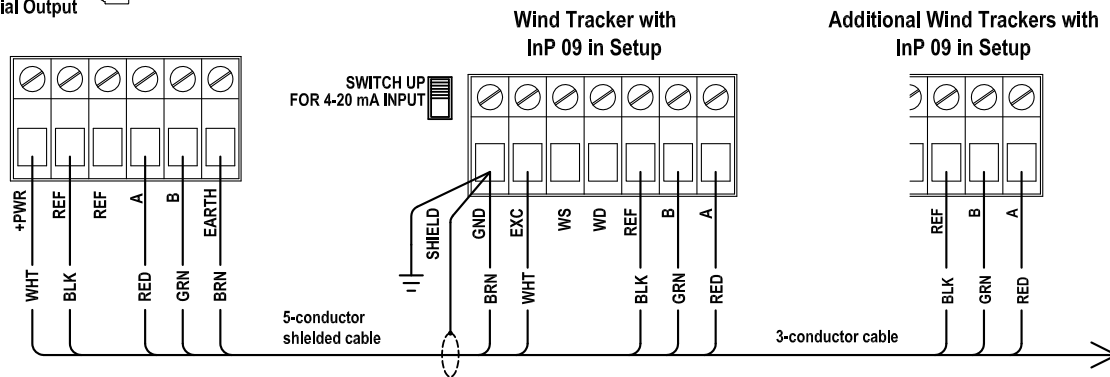
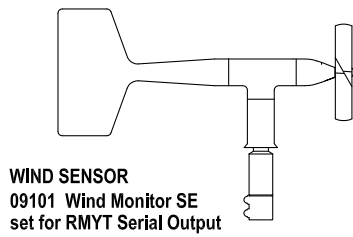
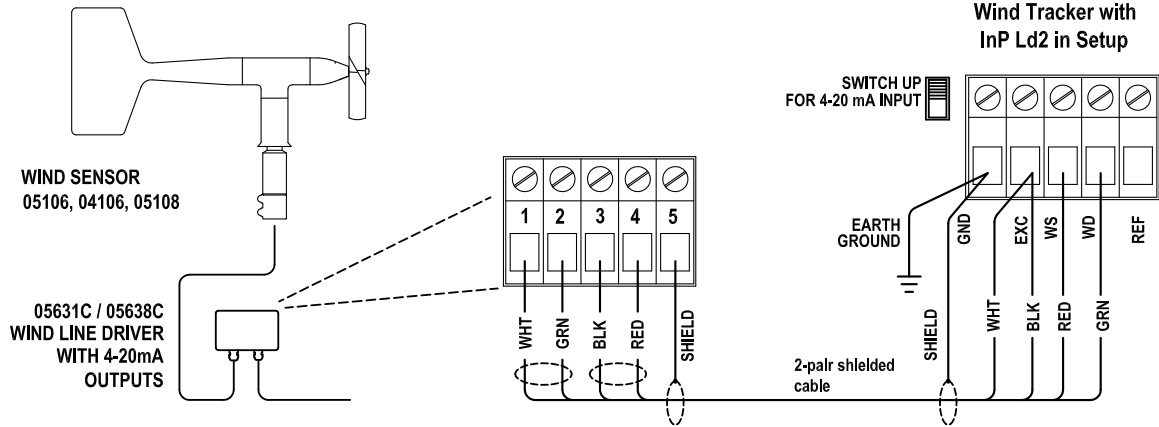

Model 86000 / 86106
Ultrasonic Anemometer

SENSOR SETTINGS:
Output Mode: RS-485 Output Only
Output Format: RMYT
Baud Rate: 9600

Use shielded cable.
Connect earth ground as shown.

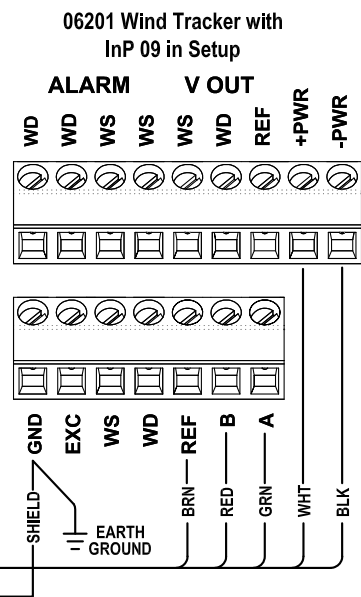
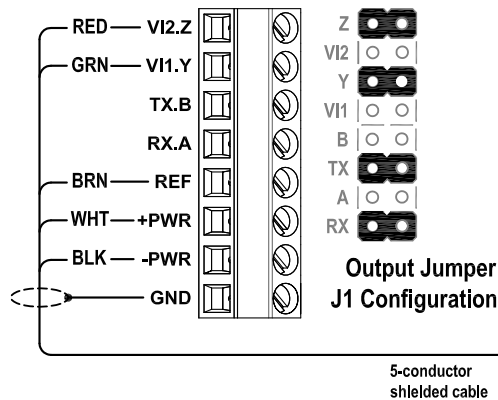

WIRING DIAGRAMS

Master-Remote Display Example

Master Wind Tracker with non-serial sensor input

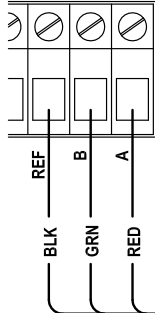

Remote Wind Tracker with InP SER in Setup

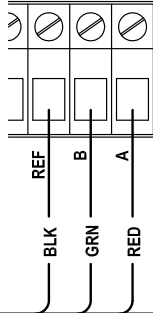

Remote Wind Tracker with InP SER in Setup

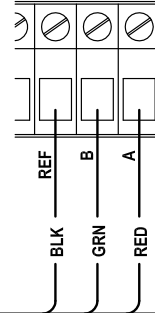

3-conductor cable

3-conductor cable

3-conductor cable

ALARM

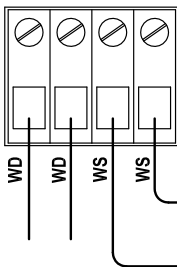

Alarm Device

User-supplied power for Alarm Circuit.
Alarm contacts 24 VAC or 30 VDC maximum
5 A resistive or 2 A inductive maximum

V OUT

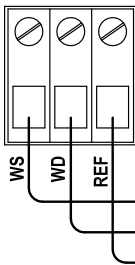

Wind Speed Vout, 0.00 to 5.00 VDC = 0 to 100 m/s
Wind Direction Vout, 0.00 to 5.00 VDC = 0 to 360 or 540 degrees
Vout Reference

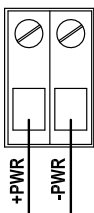

12 to 30 VDC, 3.5 watts max
Power terminals are electrically parallel with coaxial power jack. Either may be used to supply power to Wind Tracker.

DO NOT CONNECT MORE THAN ONE POWER SOURCE AT THE SAME TIME.